

Varenummer: 03493045
Beskrivelse: Fluro Heavy Duty Ledhoved EAL 45 EW-2RS
M42x3 Udvendig gevind
Note: 45

Mål

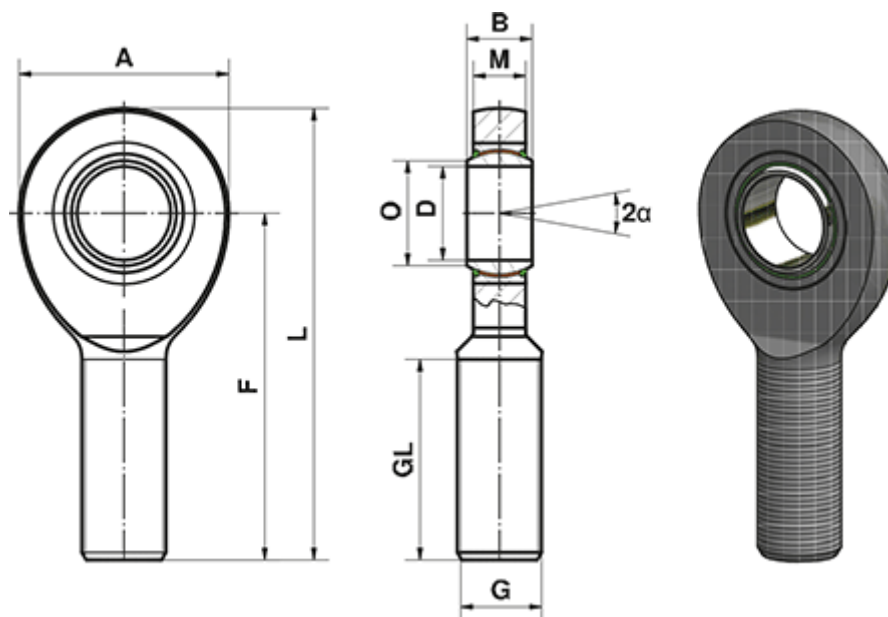

A	= 102	L	= 214
a (grader)	= 7	M	= 25
B	= 32	O	= 50.7
D	= 45	Statisk belastning C0 (kN)	= 263
Dynamisk belastning C (kN)	= 360	Vægt (g)	= 2610
F	= 163		
G	= M42x3		
GL	= 94		